

1096M-4 Adjustable Door Closer

Part Number: 11096M00004

⚠ CAUTION

For operator safety, model no. 1096M-4 Door Closer should be mounted as low as possible on door.

This is a high tension device. Improper use can lead to injury. Tension adjustment maximum wind up 1-revolution (8 notches).

DIRECTIONS

1. Flush Doors (Fig. 1)

Align the side of the plate with the edge of the jamb.

Offset Doors (Fig. 2)

Align the side of the plate with the edge of the door.

Note: Mark starting hole and install door closer as shown on door jamb with 1/4" fasteners

- Install roller guide on door as shown using 1/4" fasteners. Cam rise hinges will require the assembly to be mounted as shown to accommodate door rise.
- Open door fully to check function and clearance of parts before winding door closer.

4. To Wind

Right Hand Installation:

Turn hex nut on top with 5/8" hex wrench clockwise (in direction of arrows)

Left Hand Installation:

Turn hex nut on top with 5/8" hex wrench counter clockwise (in direction of arrows)

5. To Unwind

Turn 5/8" hex nut in direction of arrows slightly to remove load from pin

While holding load, pull the pin out (pin should move freely when there is no load)

Slowly let wrench rotate opposite of arrows and release pin, pin will automatically find next index spot

Repeat steps above until no tension is left on closer

6. Tension Adjustment

If tension adjustments are required after a period of use, remove all tension on door closer and retighten to the required torque setting.

FIG. 1

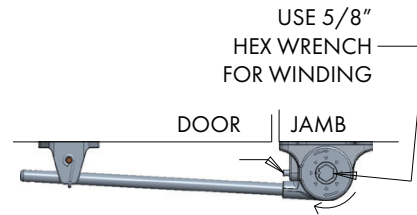
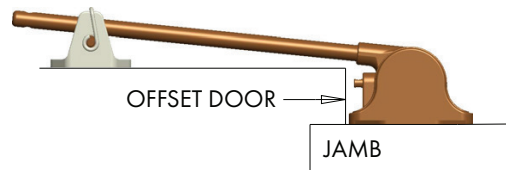
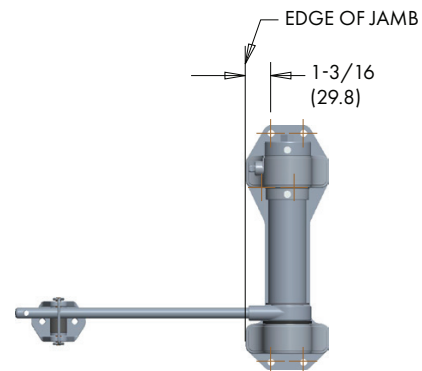

FIG. 2



RIGHT HAND INSTALLATION (SEE STEP 2)



LEFT HAND INSTALLATION (SEE STEP 2)

